

SCHÉMAS DE BRANCHEMENT

ET 20

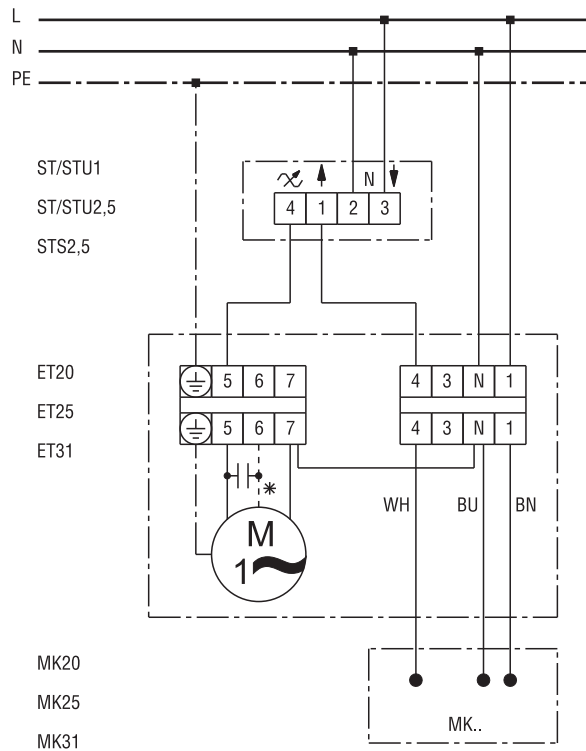

ET 20

