

SCHÉMAS DE BRANCHEMENT

ET 31

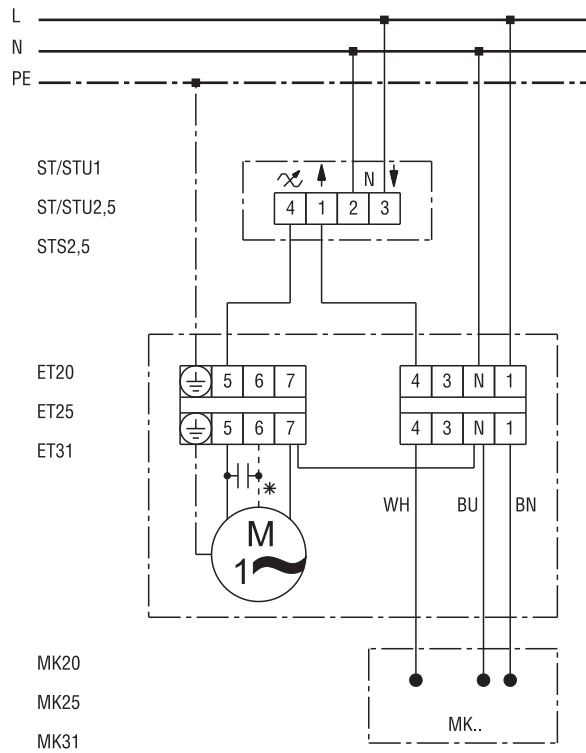

ET 31

