

ASP 150



Kratka informacija

Zaporni klizač za obložene spirokanale, DN 150

Broj artikla

0092.0435

Tehnički podaci

Vrsta ugradnje	Podžbukno
Temperatura okoline	60 °C
Jedinica za pakiranje	1 kom
Asortiman	K
GTIN (EAN)	4012799924357

Crtež s veličinama [mm]

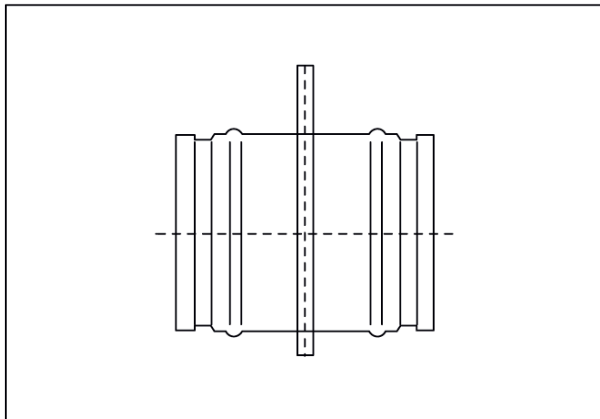

DN

150