

GRK R 25/4 D Ex



Kratka informacija

Radijalno puhalo od plastike s okruglim ispuhom, 4-polni, ugradna veličina 250, trofazna struja, protueksplozivna zaštita, medij: plin

Primjeri primjene

Okruženje s opasnošću od eksplozije (zona 2), Odsisavanje na radnom mjestu, Laboratorijski odvod, Digestorij

Broj artikla

0073.0443

Tehnički podaci

Volumen zraka	1.050 m ³ /h
Brzina	1.440 1/min
Tip propelera	radijalni
S mogućnošću upravljanja brzinom	✓
Mogućnost obrnutog načina rada	–
Vrsta napona	Trofazna struja
Nazivni napon	400 V
Frekvencija struje	50 Hz
Nominalna snaga	120 W
I _{Nomin.}	0,51 A
Vrsta zaštite	IP 55
Toplinska klasa	F
Moguća promjena pola	–
Mjesto ugradnje	Cijevni priključak
Položaj za ugradnju	horizontalno
Materijal kućišta	Plastika, polietilen
Materijal propelera	Plastika, polipropilen
Boja	crna
Težina	24 kg
Težina s pakovanjem	47 kg
Širina	440 mm
Visina	500 mm
Dubina	453 mm
Širina s pakovanjem	1.200 mm
Visina s pakovanjem	800 mm
Dubina s pakovanjem	650 mm
Oznaka EX u skladu s Direktivom ATEX	Ex II 3 G
Oznaka EX u skladu s normom	Ex db IIB+H2 T4 Gb X / Ex h IIB+H2 T4 Gb X
Temperatura okoline Ta	-20 °C ≤ Ta ≤ +40 °C

GRK R 25/4 D Ex

Način rada	S1
PTC DIN 44082	M 100
Klasa temperature	T4
Jedinica za pakiranje	1 kom
Asortiman	C
GTIN (EAN)	4012799734437

Razina jačine zvuka u opsegu buke

	63 Hz	125 Hz	250 Hz	500 Hz	1 kHz	2 kHz	4 kHz	8 kHz	Ukupno
L_{WA5, S5} (dB(A))	43,1	55,2	63,7	64,1	66,3	62,5	54,3	44,2	71

L_{WA5} = razina jačine zvuka slobodnog usisa u dB

Krivulja

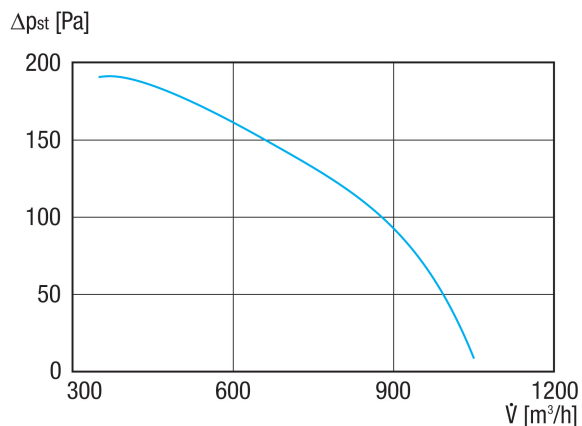

GRK R 25/4 D Ex

Crtež s veličinama [mm]

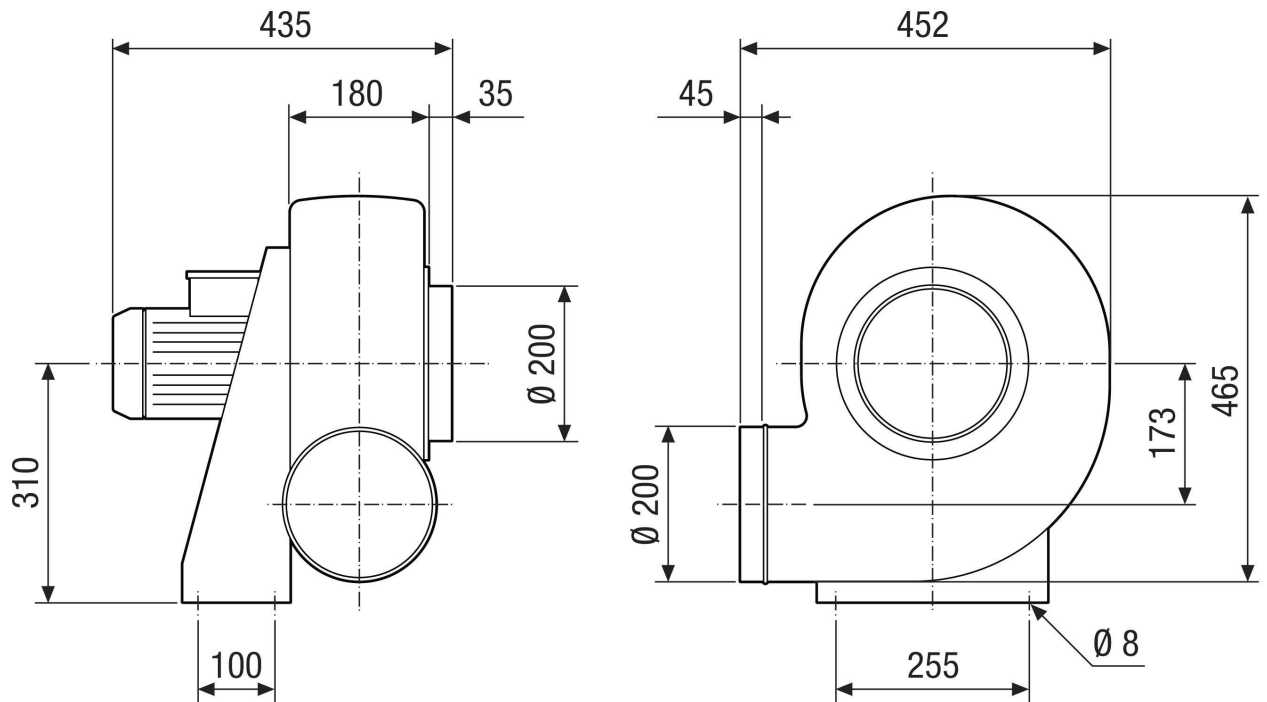

GRK R 25/4 D Ex

Crtež s veličinama Poravnanje kućišta [mm]

①						
	0°	45°	90°	135°	270°	315°
②						

- ① Model na desnoj strani
② Model na lijevoj strani