

RO 180



Kratka informacija

Otvor za čišćenje s brtvom s valjanim prstenom za obložene spirokanale, DN 180

Broj artikla

0092.0410

Tehnički podaci

Vrsta ugradnje	Podžbukno
Temperatura okoline	60 °C
Jedinica za pakiranje	1 kom
Asortiman	K
GTIN (EAN)	4012799924104

Crtež s veličinama [mm]

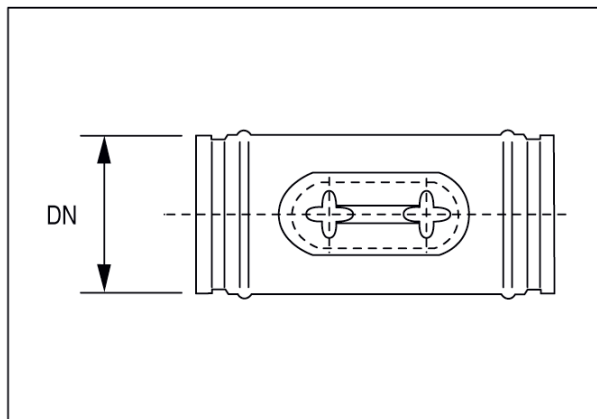

DN

180