

RSK 150



Kratka informacija

Štitnik od povratnog toka za obložene spirokanale, DN 150

Broj artikla

0092.0428

Tehnički podaci

Vrsta ugradnje	Podžbukno
Temperatura okoline	60 °C
Jedinica za pakiranje	1 kom
Asortiman	K
GTIN (EAN)	4012799924289

Crtež s veličinama [mm]

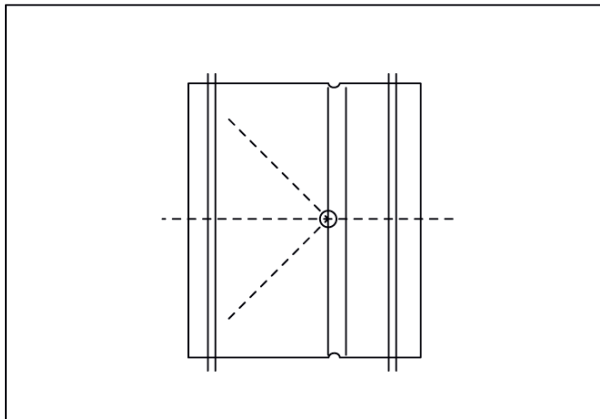

DN

150