

RSK 160



Kratka informacija

Štitnik od povratnog toka za obložene spirokanale, DN 160

Broj artikla

0092.0429

Tehnički podaci

Vrsta ugradnje	Podžbukno
Temperatura okoline	60 °C
Jedinica za pakiranje	1 kom
Asortiman	K
GTIN (EAN)	4012799924296

Crtež s veličinama [mm]

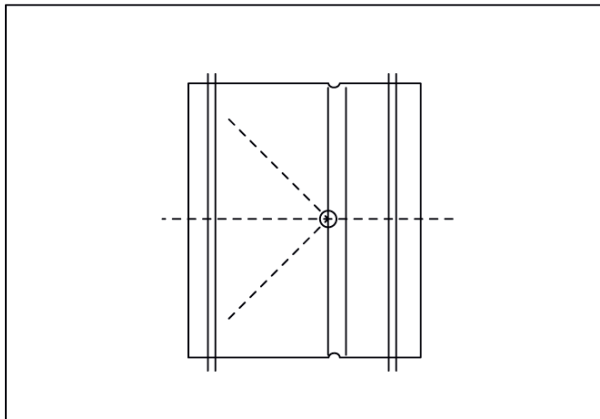

DN

160