

RSK 180



Kratka informacija

Štitnik od povratnog toka za obložene spirokanale, DN 180

Broj artikla

0092.0430

Tehnički podaci

Vrsta ugradnje	Podžbukno
Temperatura okoline	60 °C
Jedinica za pakiranje	1 kom
Asortiman	K
GTIN (EAN)	4012799924302

Crtež s veličinama [mm]

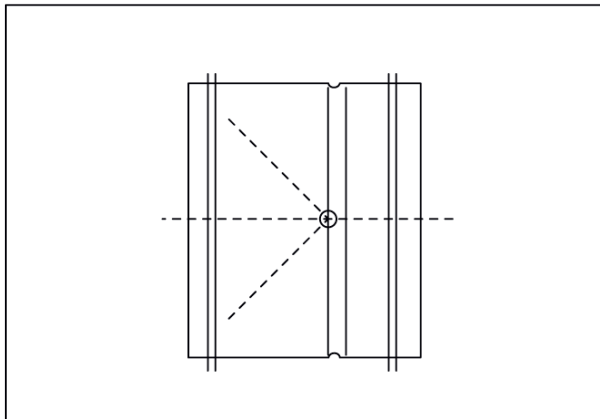

DN

180