

RSK 200



Kratka informacija

Štitnik od povratnog toka za obložene spirokanale, DN 200

Broj artikla

0092.0431

Tehnički podaci

Vrsta ugradnje	Podžbukno
Temperatura okoline	60 °C
Jedinica za pakiranje	1 kom
Asortiman	K
GTIN (EAN)	4012799924319

Crtež s veličinama [mm]

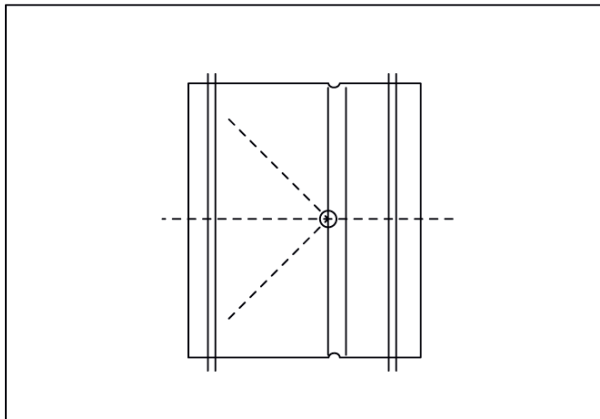

DN

200