

DZD30-2A

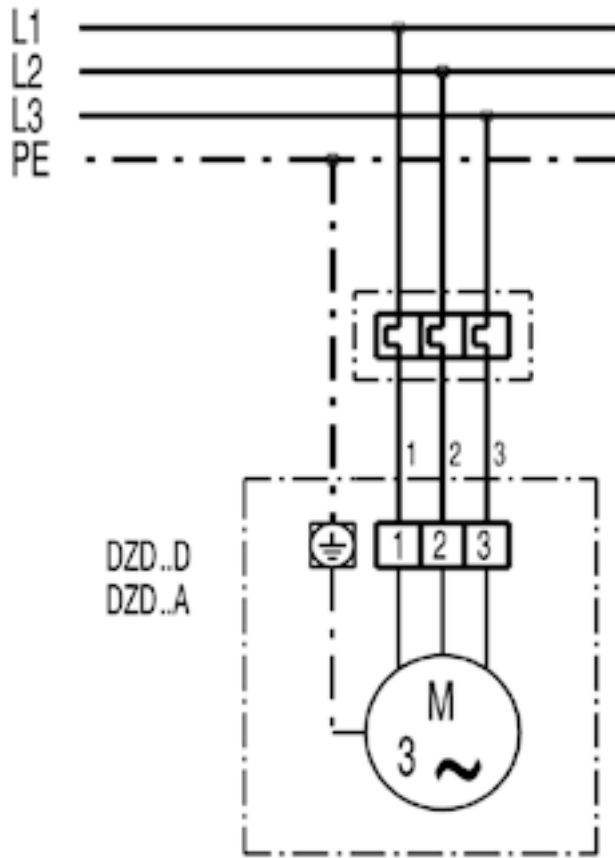

DZD...D sa žaluzinom VE, RKP i servomotorom MS 8, MS 8 P

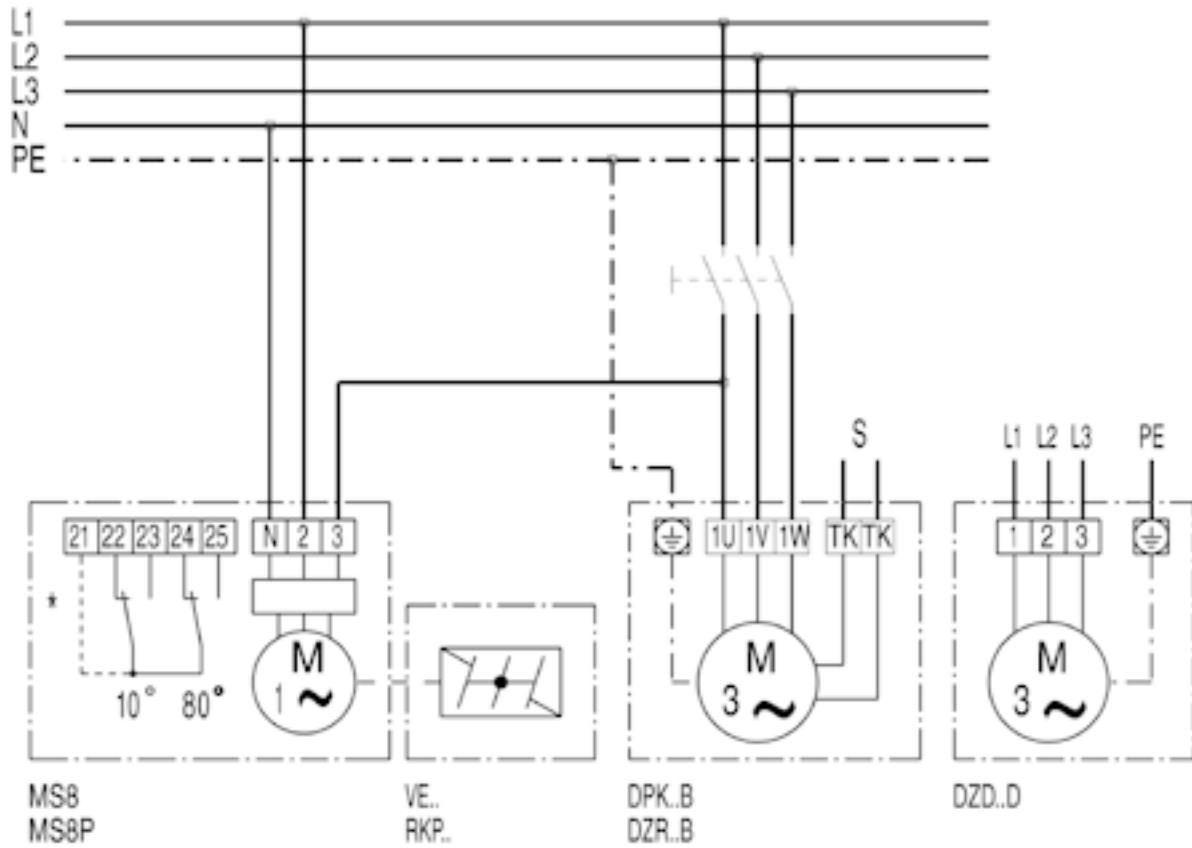

* Sklopka krajnjeg položaja MS 8 P
S Regulacijski krug