

# EZF 45/6 B

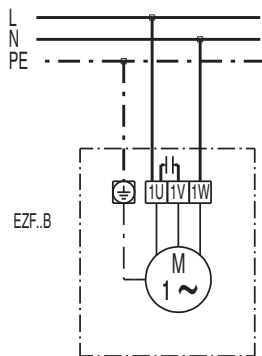

EZF 45/6 B

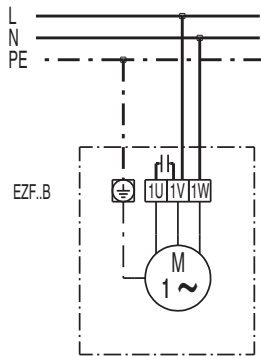
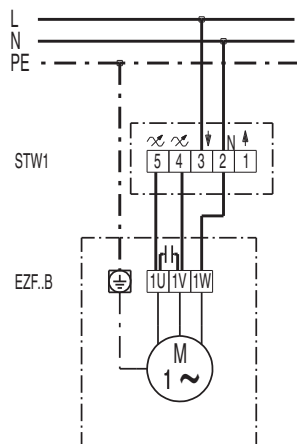
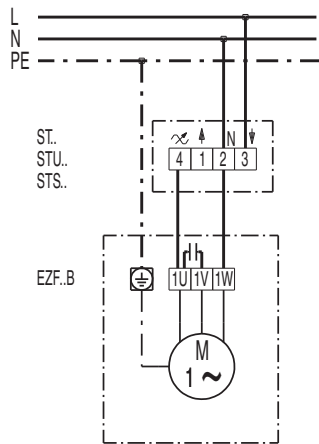

EZF 45/6 B

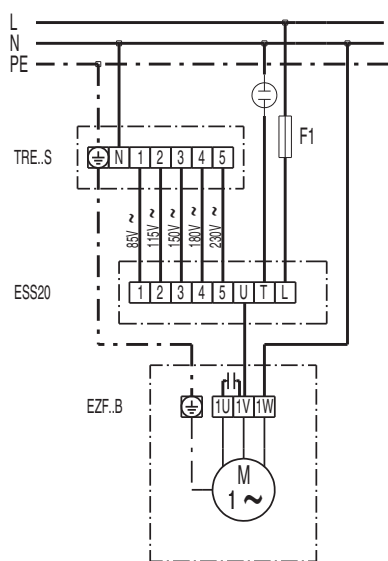
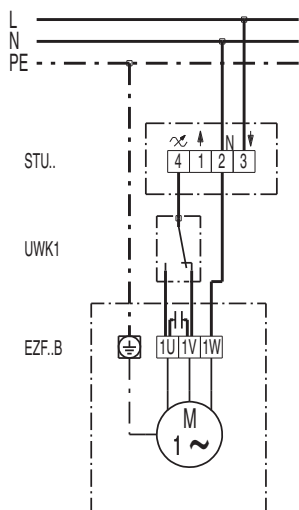

# EZF 45/6 B

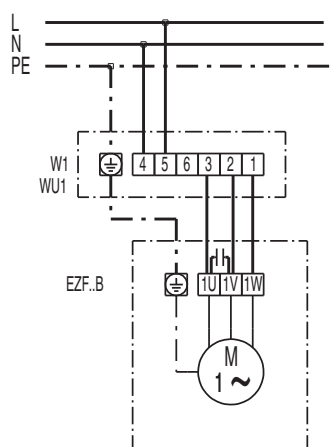
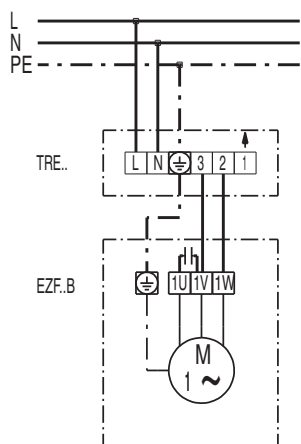

# PRIKLJUČNE SCHEME

## EZF 45/6 B

