

PRIKLJUČNE SCHEME

EZF 50/8 B

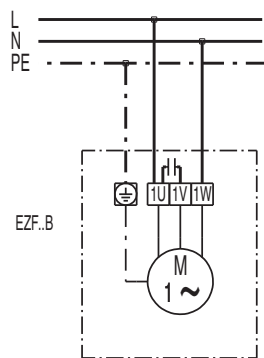

EZF 50/8 B

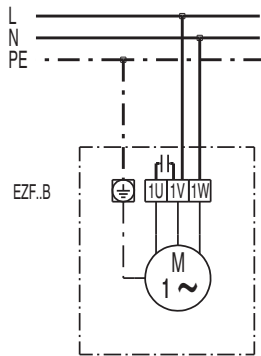
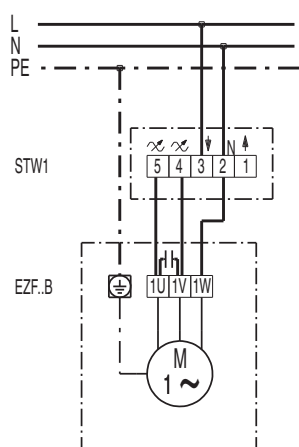
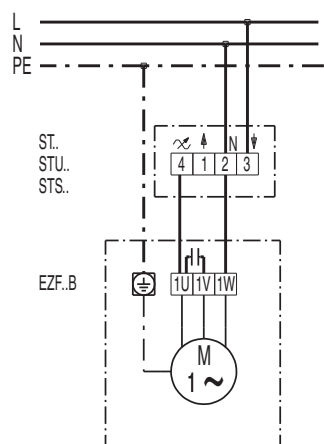

EZF 50/8 B

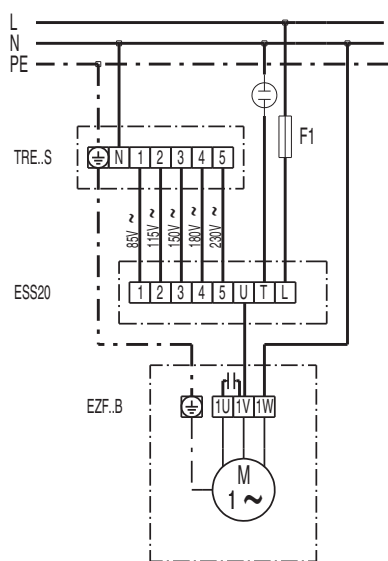
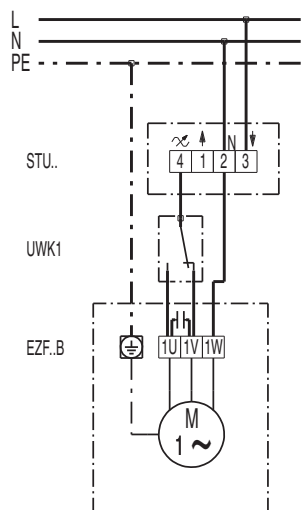

EZF 50/8 B

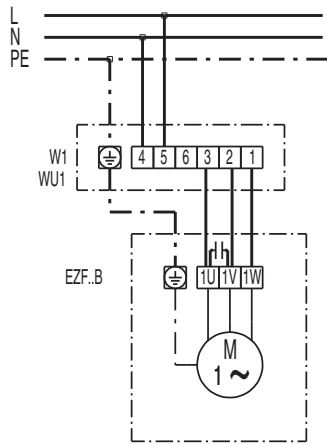
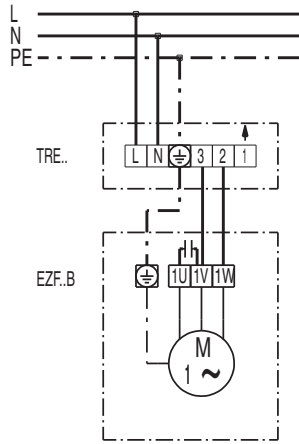

PRIKLJUČNE SCHEME

EZF 50/8 B

