

EZQ / EZS..B kretanje udesno

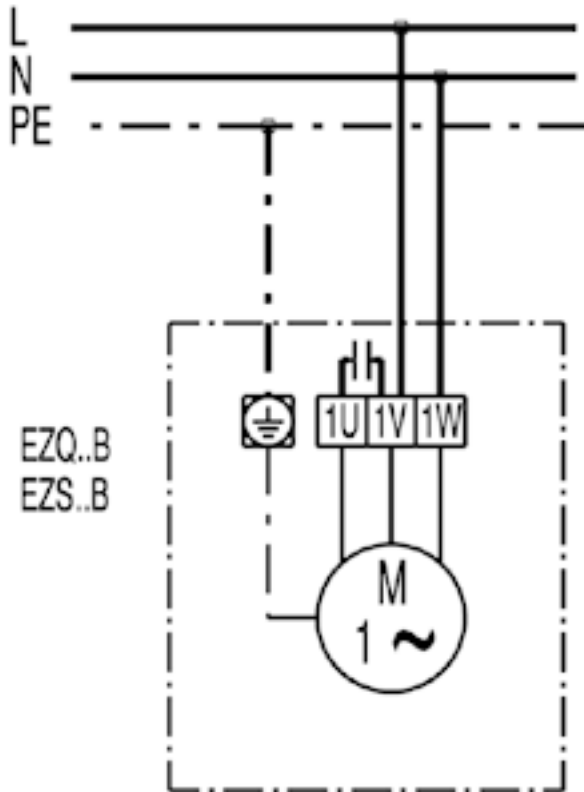

EZQ 20/2 B

EZQ / EZS..B kretanje ulijevo

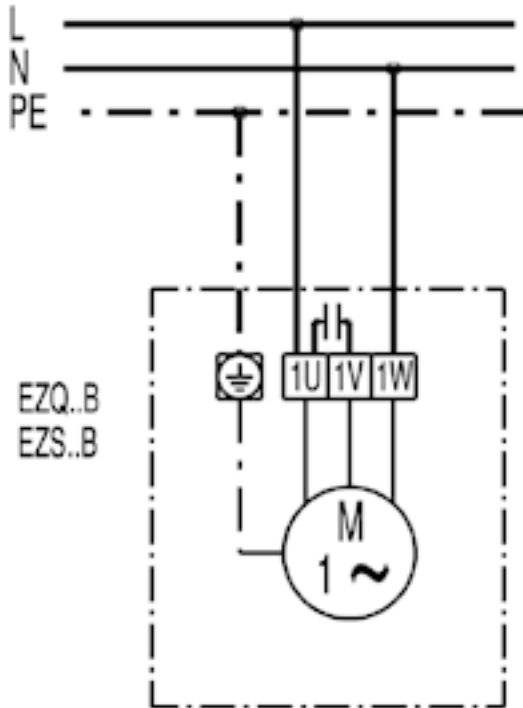

EZQ 20/2 B



EZQ / EZS..B s reverzibilnom sklopkom ST / STU / STS kretanje ulijevo

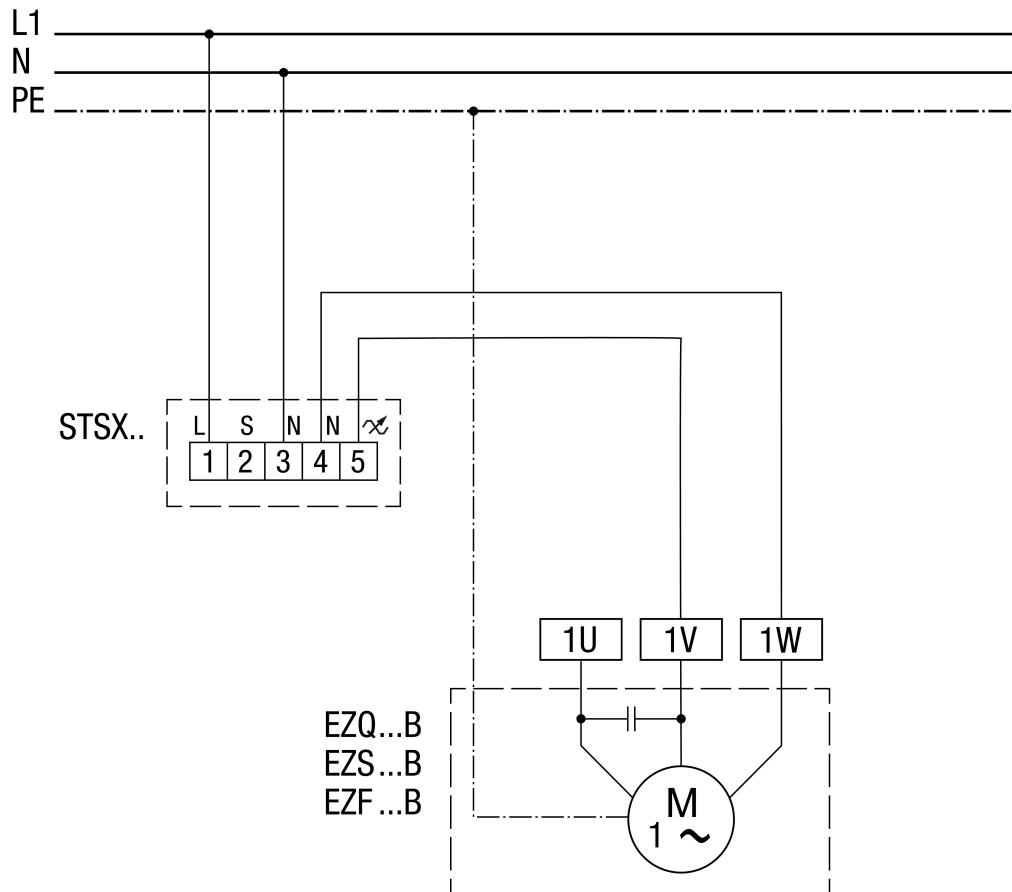

EZQ 20/2 B

EZQ / EZS..B s regulatorom brzine STW1

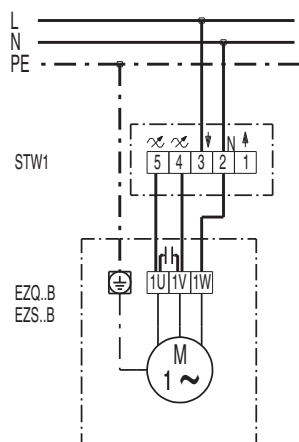

EZQ / EZS..B s reverzibilnom sklopkom UKW 1 i regulatorom brzine STU..

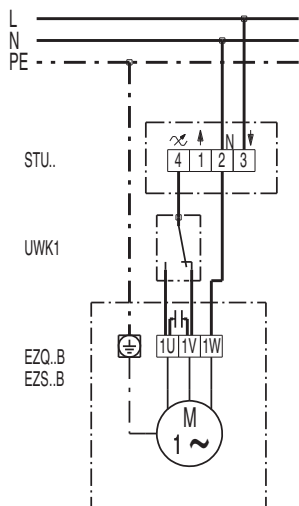

EZQ 20/2 B

EZQ / EZS..B s petostupanjskim transformatorom TRE..S / Tr..S i petostupanjskom sklopkom ESS20

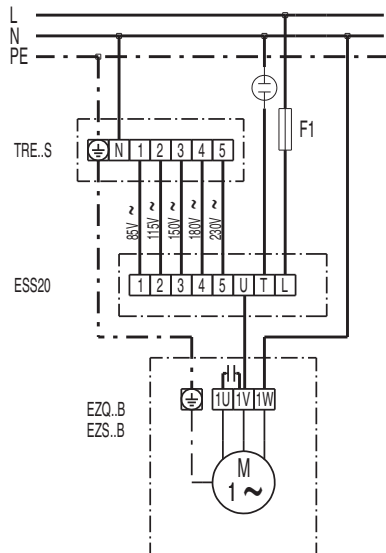

EZQ / EZS..B s petostupanjskim transformatorom TRE..

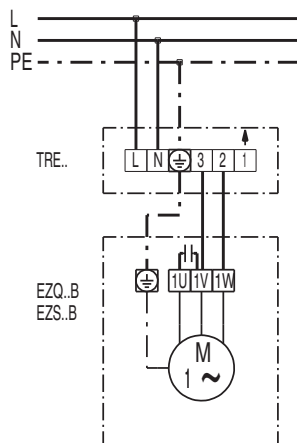

EZQ 20/2 B

EZQ / EZS..B s reverzibilnom sklopkom W1 / WU1

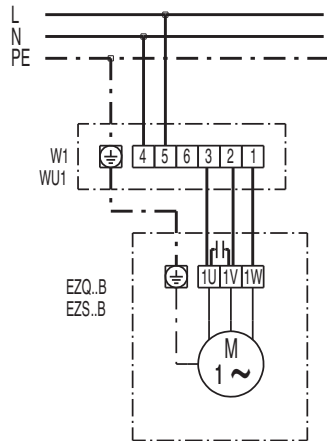

EZQ / EZS..B s reverzibilnom sklopkom FS 7

