

EZS 30/6 B

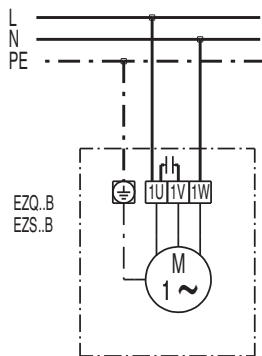

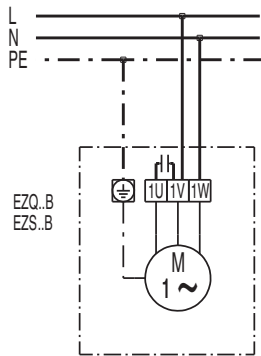

EZS 30/6 B

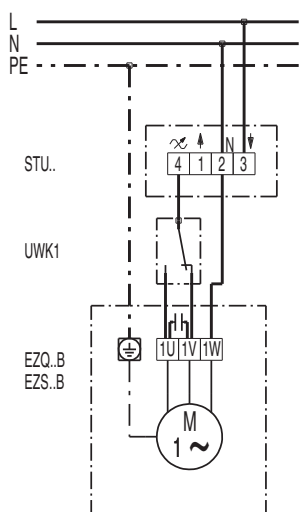
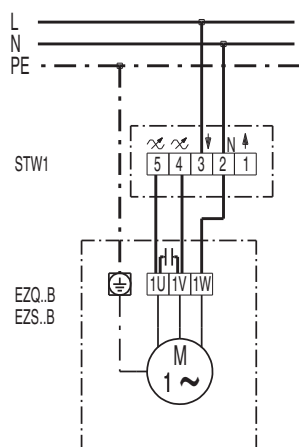

PRIKLJUČNE SCHEME

EZS 30/6 B

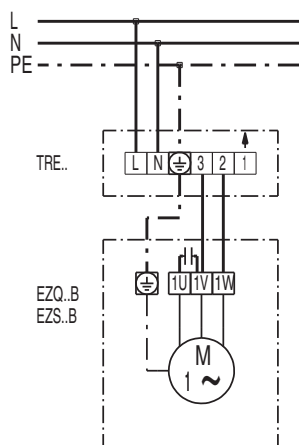
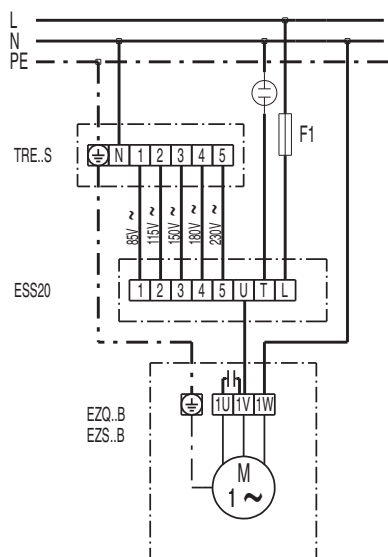

EZS 30/6 B

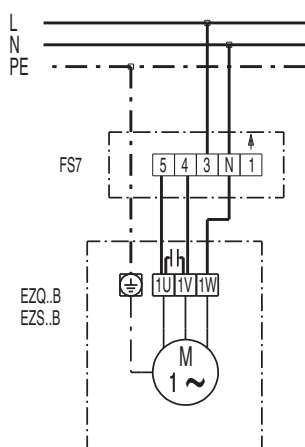
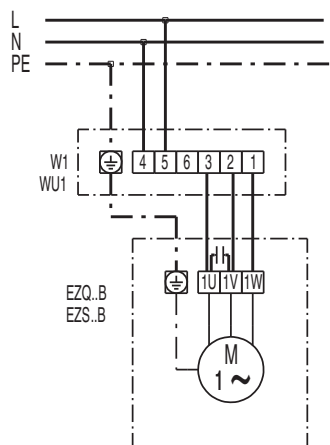

EZS 30/6 B

