

DZF 40/8 B

DZQ/DZS/DZF..B Standard (jobbraforgás, 1 fordulatszám)

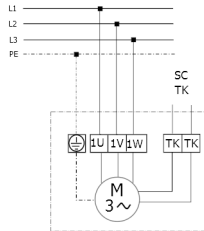

SC - védőérintkező
TK - hőérintkező

DZQ/DZS/DZF..B Standard (balraforgás, 1 fordulatszám)

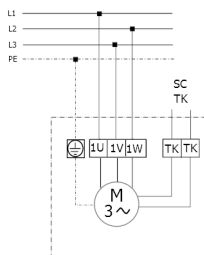

SC - védőérintkező
TK - hőérintkező

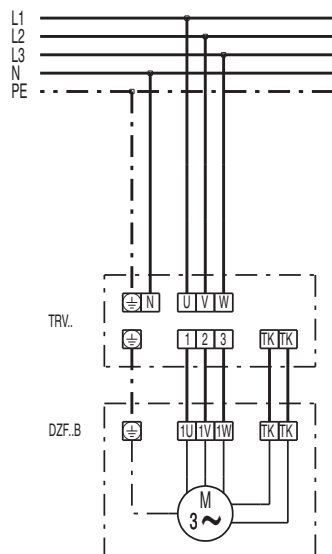

DZF 40/8 B

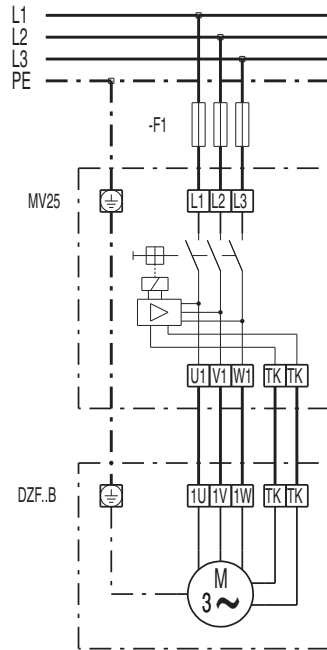

DZF 40/8 B

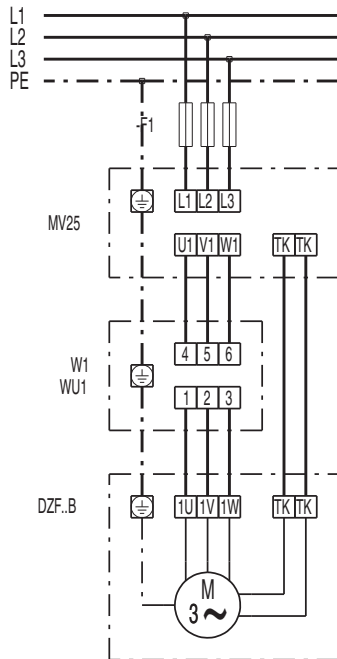

DZF 40/8 B

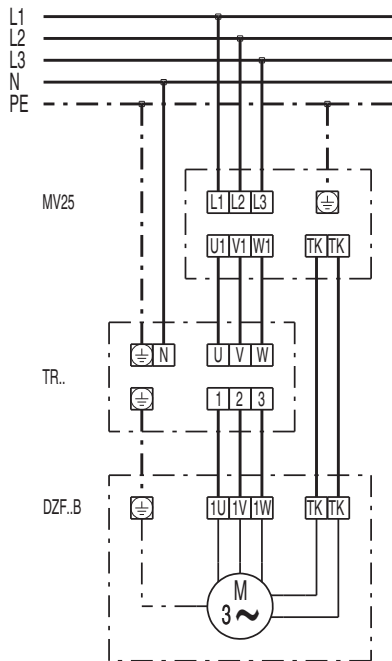

DZF 40/8 B

