

DZQ 35/2 B

DZQ/DZS/DZF..B Standard (jobbraforgás, 1 fordulatszám)



SC - védőérintkező
TK - hőérintkező

DZQ/DZS/DZF..B Standard (balraforgás, 1 fordulatszám)

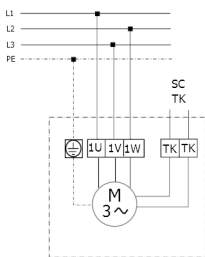

SC - védőérintkező
TK - hőérintkező

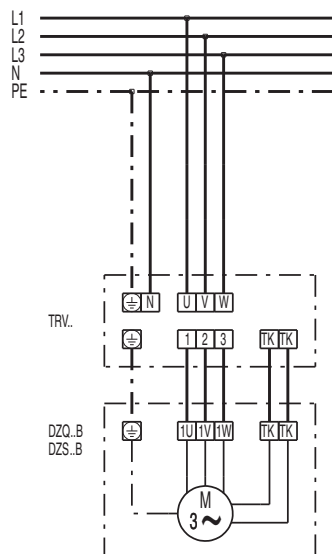

DZQ 35/2 B



DZQ 35/2 B

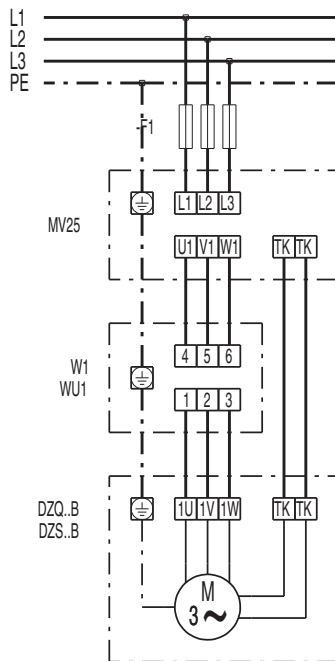

DZQ 35/2 B



DZQ 35/2 B

