

# DZQ 45/6 B

## DZQ/DZS/DZF..B Standard (jobbraforgás, 1 fordulatszám)

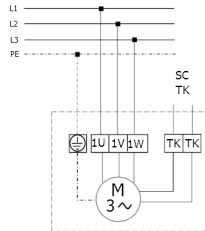

SC - védőérintkező  
TK - hőérintkező

## DZQ/DZS/DZF..B Standard (balraforgás, 1 fordulatszám)

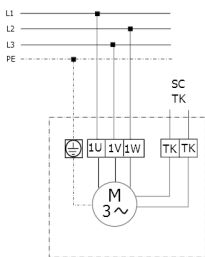

SC - védőérintkező  
TK - hőérintkező

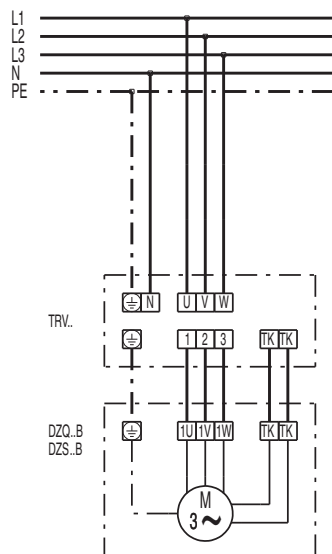

DZQ 45/6 B

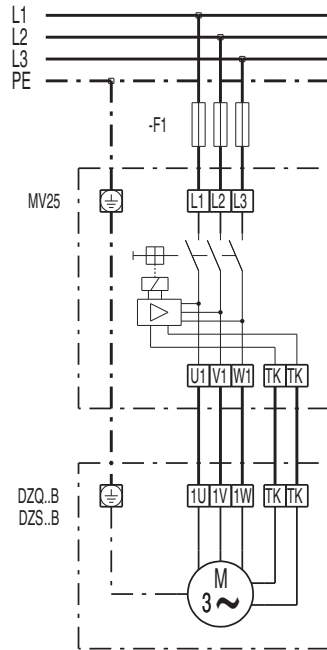

DZQ 45/6 B

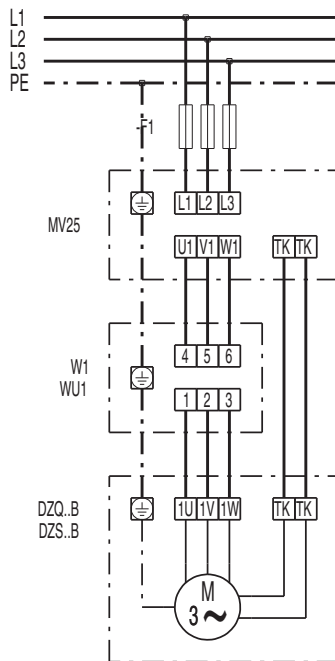

DZQ 45/6 B

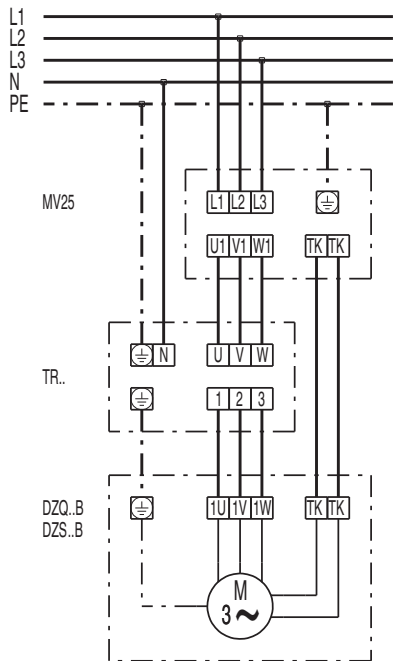

DZQ 45/6 B

