

# DZS 30/4 B

## DZQ/DZS/DZF..B Standard (jobbraforgás, 1 fordulatszám)



SC - védőérintkező  
TK - hőérintkező

## DZQ/DZS/DZF..B Standard (balraforgás, 1 fordulatszám)

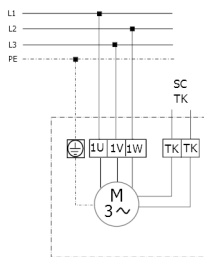

SC - védőérintkező  
TK - hőérintkező

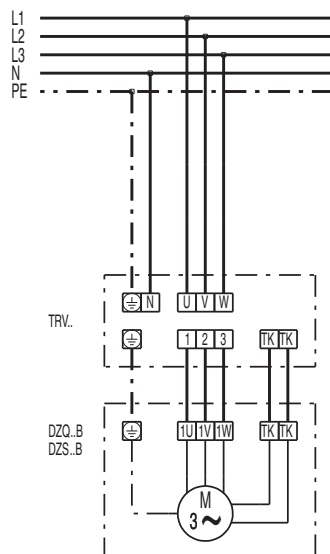

DZS 30/4 B



DZS 30/4 B

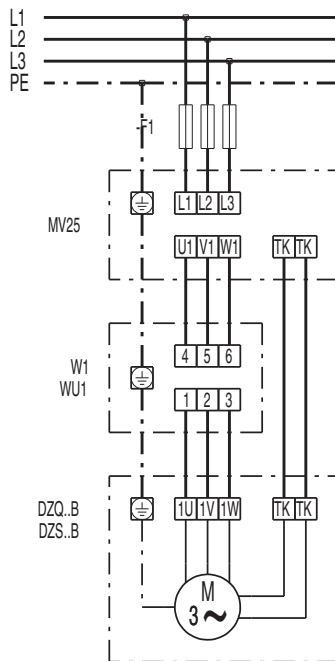

DZS 30/4 B



DZS 30/4 B

