

# DZS 35/2 B

## DZQ/DZS/DZF..B Standard (jobbraforgás, 1 fordulatszám)



SC - védőérintkező  
TK - hőérintkező

## DZQ/DZS/DZF..B Standard (balraforgás, 1 fordulatszám)

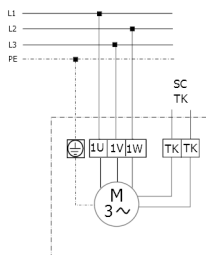

SC - védőérintkező  
TK - hőérintkező

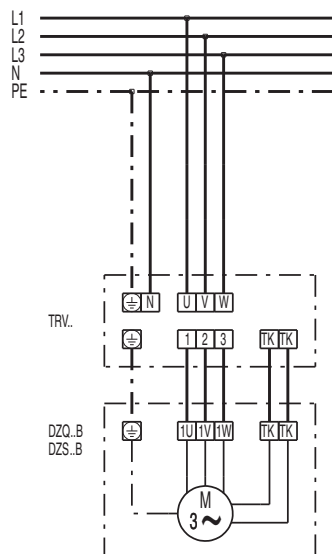

DZS 35/2 B



DZS 35/2 B

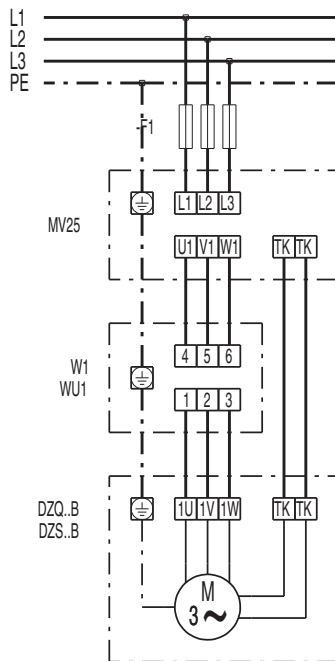

DZS 35/2 B



DZS 35/2 B

