

EPK 25/6 B

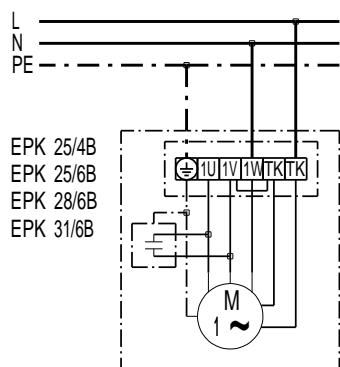

EPK 25/4 B, 25/6 B

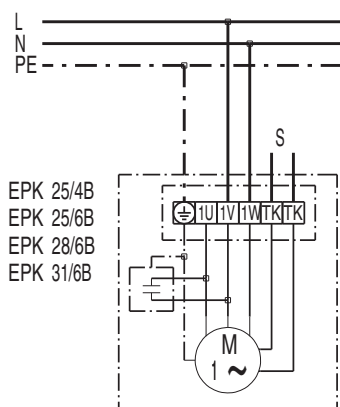

S = obwód sterujący zgłoszenia usterki

EPK 25/6 B

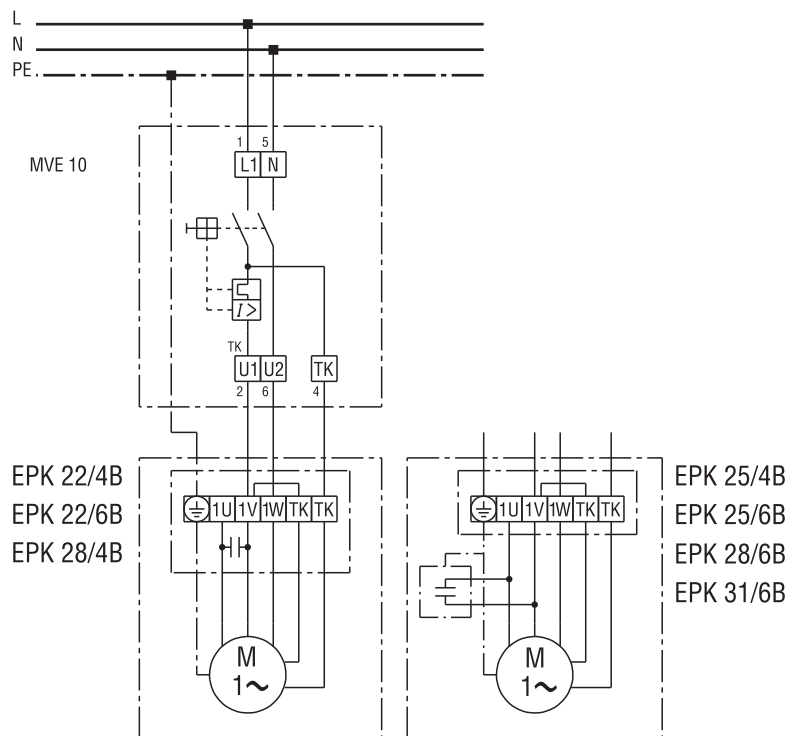

EPK 25/6 B

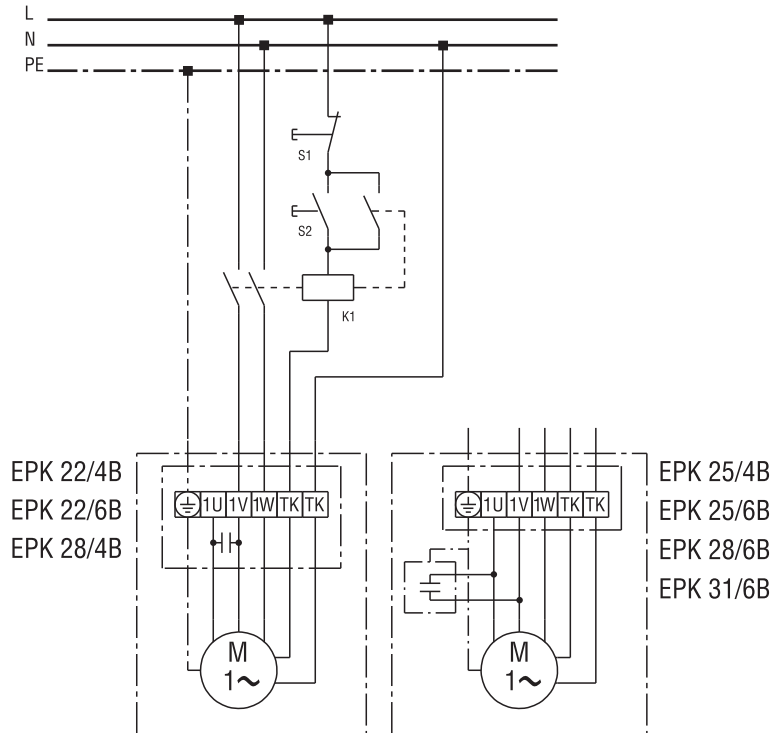

EPK 25/6 B

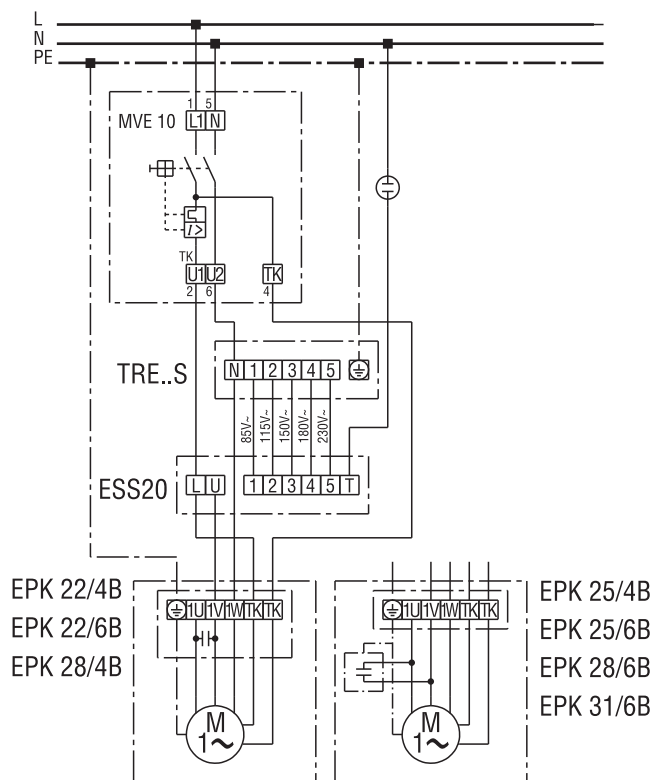

EPK 25/6 B

