

EPK 28/6 B

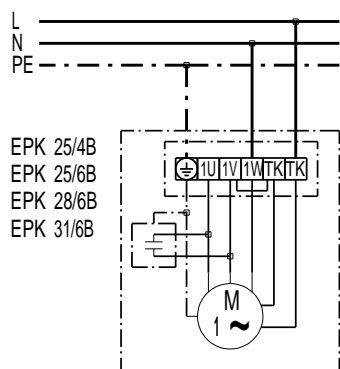

EPK 28/6 B

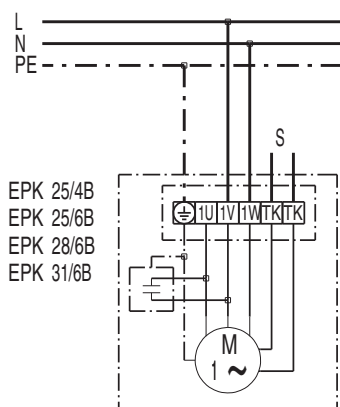

S = obwód sterujący zgłoszenia usterki

EPK 28/6 B

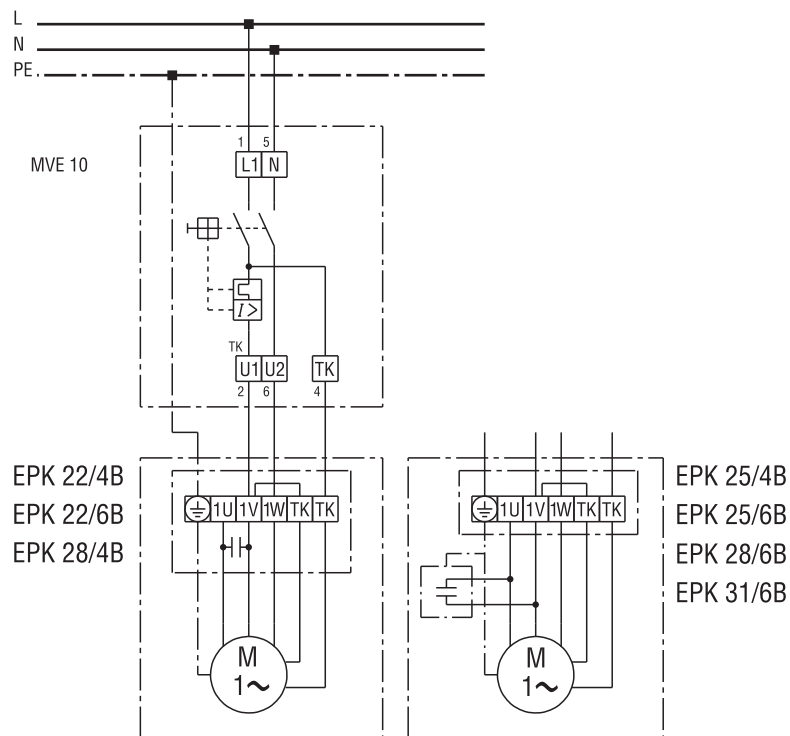

EPK 28/6 B

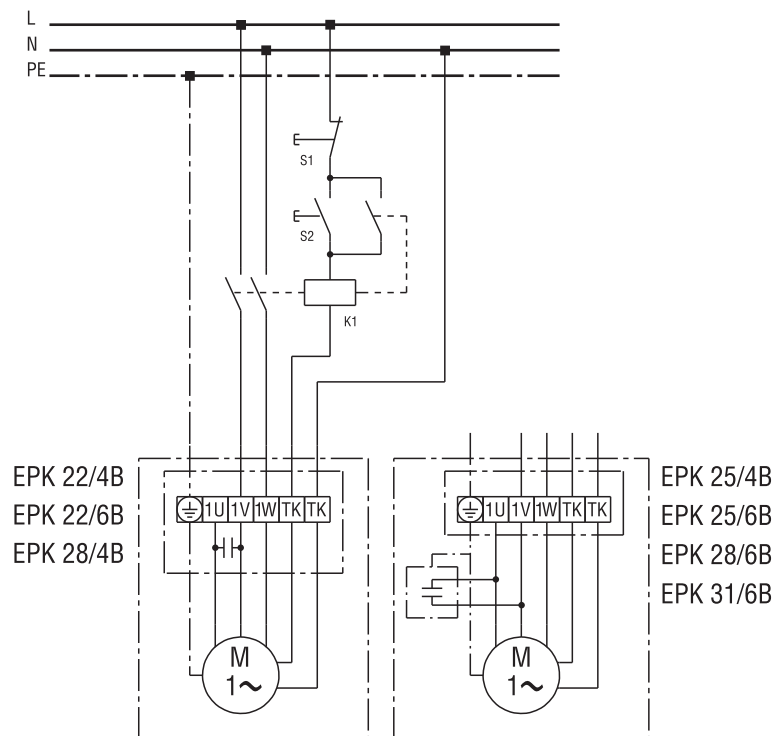

EPK 28/6 B

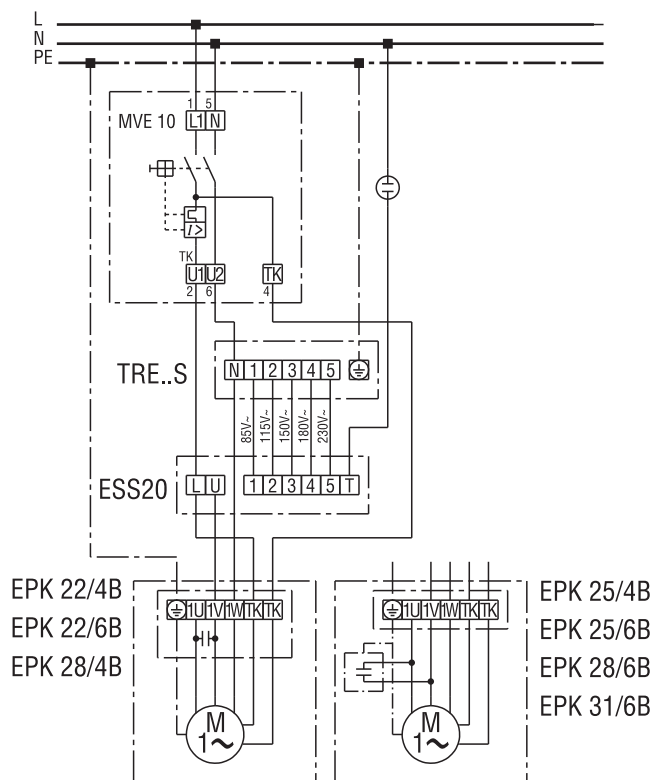

EPK 28/6 B

